

# Austin pergola 4 x 3 meter

## Monteringsanvisning

---

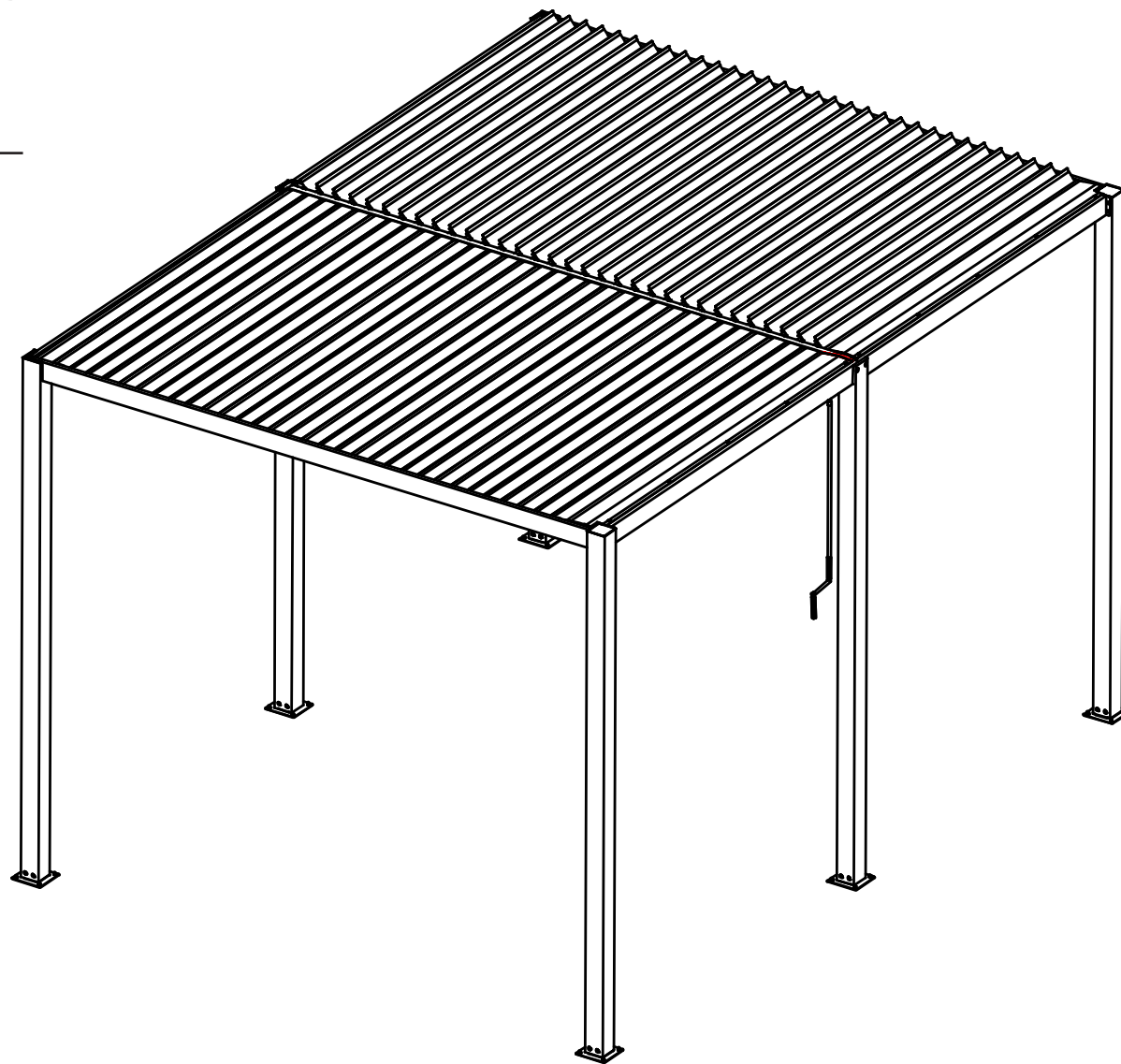

Artnr. 17025

Varéti importeres av Hartman Nordic AS  
[www.vareti.no](http://www.vareti.no) / [post@hartman.no](mailto:post@hartman.no) / Tlf. 99 48 50 50

**varéti**

### SIKKERHETSÅD

Vi anbefaler pÅ det sterkeste bruk av arbeidshansker under montering.

Vær gjerne 2 personer ved montering. BÅde for Å lette jobben og for Å unngÅ ulykker.

Vis forsiktighet ved montering for Å unngÅ skade pÅ aluminiumsdelene.

UnngÅ montering i vind eller regnvær.

Bruk alltid sko og vernebriller nÅr du jobber med aluminiumsprofiler.

Terrassetaket monteres pÅ et plant, flatt underlag.

Ikke len deg mot eller skyv pÅ taket under montering.

Ikke plasser terrassetaket i et område som er utsatt for mye vind.

Varme gjenstander som for eksempel nylig brukte griller, mÅ ikke lagres under taket.

### GENERELLE RÅD

Dette er en flerdelt montering, beregn god tid.

Terrassetaket bÅr plasseres pÅ en solrik, plan beliggenhet vekk fra overhengende trær.

Hvis du fester terrassetaket direkte til et solid betongfundament, benytt forhÅndsborede hull i den medfÅlgende metallbunnen.

Hold alle smÅ deler (skruer osv.) i en bolle slik at de ikke forsvinner.

### NÅDVENDIG VERKTÅY OG UTSTYR

Vi anbefaler bruk av hansker og langermet plagg pÅ overkroppen under installasjon for Å hindre skade fra skarpe kanter som kan forekomme pÅ stÅldelene.







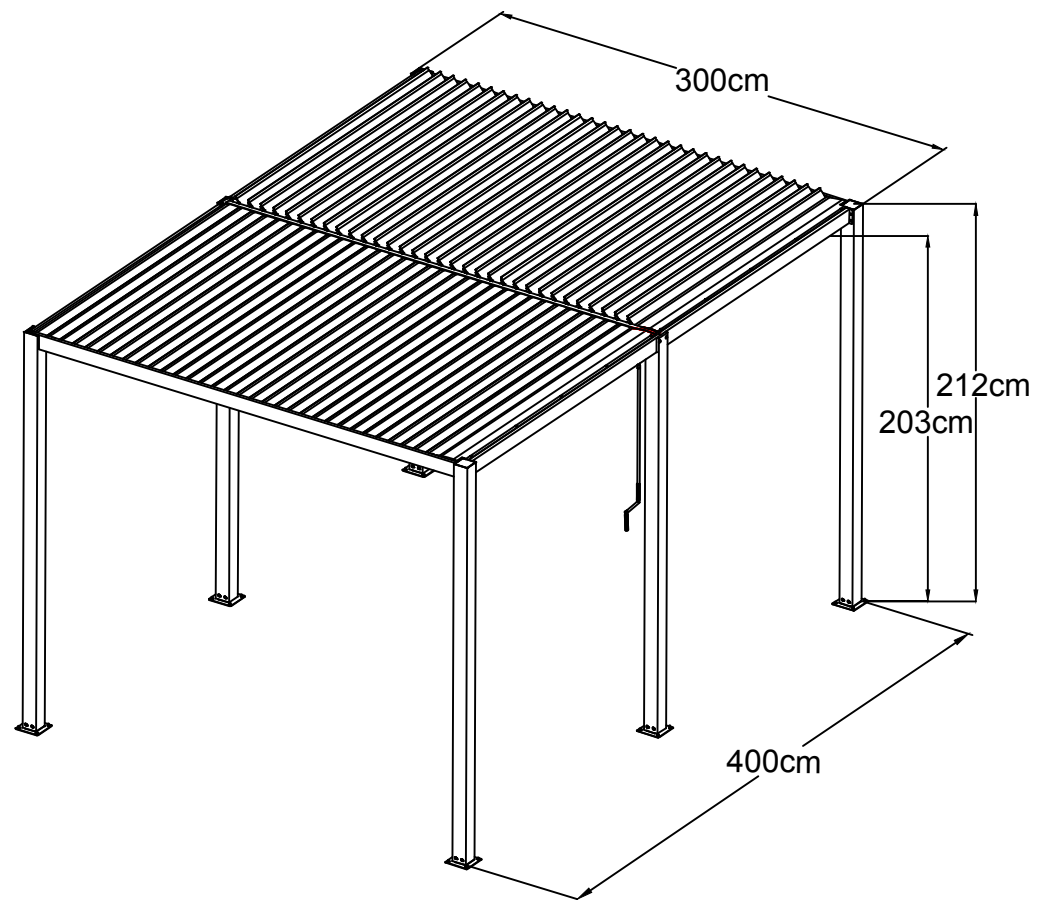







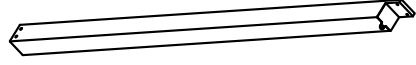









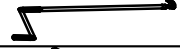







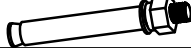



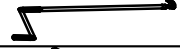







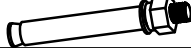



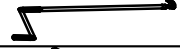







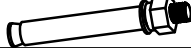



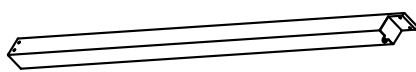





Du vil ogsÅ trenge fÅlgende:

- 5 meters mÅlebÅnd eller tommestokk
- Vinkelhake
- Vaterpass
- Gardintrapp
- 12 mm og 14 mm fastnÅkkel eller skrallenÅkkel, **evnt** skiftenÅkkel
- Elektrisk drill med 3, 4 og 5 mm sekskantnÅkkel-bits **evnt** 3, 4 og 5 mm sekskantnÅkkel
- Gummiklubbe eller treklubbe
- Markeringstusj
- Silikon
- 10 mm og 12 mm metallbor
- Kniv
- Skrutrekker med stjernebit

# Mål



## Deleliste

NR.	Ant.				NR.	Ant.																																																																
Ⓐ	1		2120mm		Ⓔ	1		1943mm																																																														
Ⓑ	1		2120mm		Ⓚ	1		1943mm																																																														
Ⓒ	1		2120mm		Ⓟ	64		1939mm																																																														
Ⓓ	1		2130mm		<table border="1" style="width: 100%; border-collapse: collapse;"> <thead> <tr> <th style="width: 5%;">NR.</th> <th style="width: 5%;">Ant.</th> <th style="width: 15%;"></th> <th style="width: 15%;"></th> <th style="width: 15%;"></th> </tr> </thead> <tbody> <tr> <td>①</td> <td>6</td> <td>150X150</td> <td></td> </tr> <tr> <td>②</td> <td>2</td> <td></td> <td></td> </tr> <tr> <td>③</td> <td>1</td> <td></td> <td></td> </tr> <tr> <td>④</td> <td>2</td> <td>78X78X81.5</td> <td></td> </tr> <tr> <td>⑤</td> <td>10</td> <td>M5X15</td> <td></td> </tr> <tr> <td>⑥</td> <td>21</td> <td>M6x20</td> <td></td> </tr> <tr> <td>⑦</td> <td>24</td> <td>M8x15</td> <td></td> </tr> <tr> <td>⑧</td> <td>8</td> <td>M8x30</td> <td></td> </tr> <tr> <td>⑨</td> <td>2</td> <td>M8x35</td> <td></td> </tr> <tr> <td>⑩</td> <td>2</td> <td>M8x55</td> <td></td> </tr> <tr> <td>⑪</td> <td>2</td> <td>M8</td> <td></td> </tr> <tr> <td>⑫</td> <td>24</td> <td>M8x60</td> <td></td> </tr> <tr> <td>⑬</td> <td>24</td> <td>M8</td> <td></td> </tr> <tr> <td>⑭</td> <td>2</td> <td></td> <td></td> </tr> </tbody> </table>					NR.	Ant.				①	6	150X150		②	2			③	1			④	2	78X78X81.5		⑤	10	M5X15		⑥	21	M6x20		⑦	24	M8x15		⑧	8	M8x30		⑨	2	M8x35		⑩	2	M8x55		⑪	2	M8		⑫	24	M8x60		⑬	24	M8		⑭	2		
NR.	Ant.																																																																					
①	6	150X150																																																																				
②	2																																																																					
③	1																																																																					
④	2	78X78X81.5																																																																				
⑤	10	M5X15																																																																				
⑥	21	M6x20																																																																				
⑦	24	M8x15																																																																				
⑧	8	M8x30																																																																				
⑨	2	M8x35																																																																				
⑩	2	M8x55																																																																				
⑪	2	M8																																																																				
⑫	24	M8x60																																																																				
⑬	24	M8																																																																				
⑭	2																																																																					
Ⓔ	1		2130mm																																																																			
Ⓕ	1		2130mm																																																																			
Ⓖ	1		1964mm																																																																			
Ⓗ	1		1964mm																																																																			
Ⓘ	1		2873mm																																																																			
Ⓝ	1		2915mm																																																																			
Ⓚ	1		2873mm																																																																			
Ⓛ	1		1909mm																																																																			
Ⓜ	1		2059mm																																																																			

# Monteringsoversikt for aluminiumsprofiler

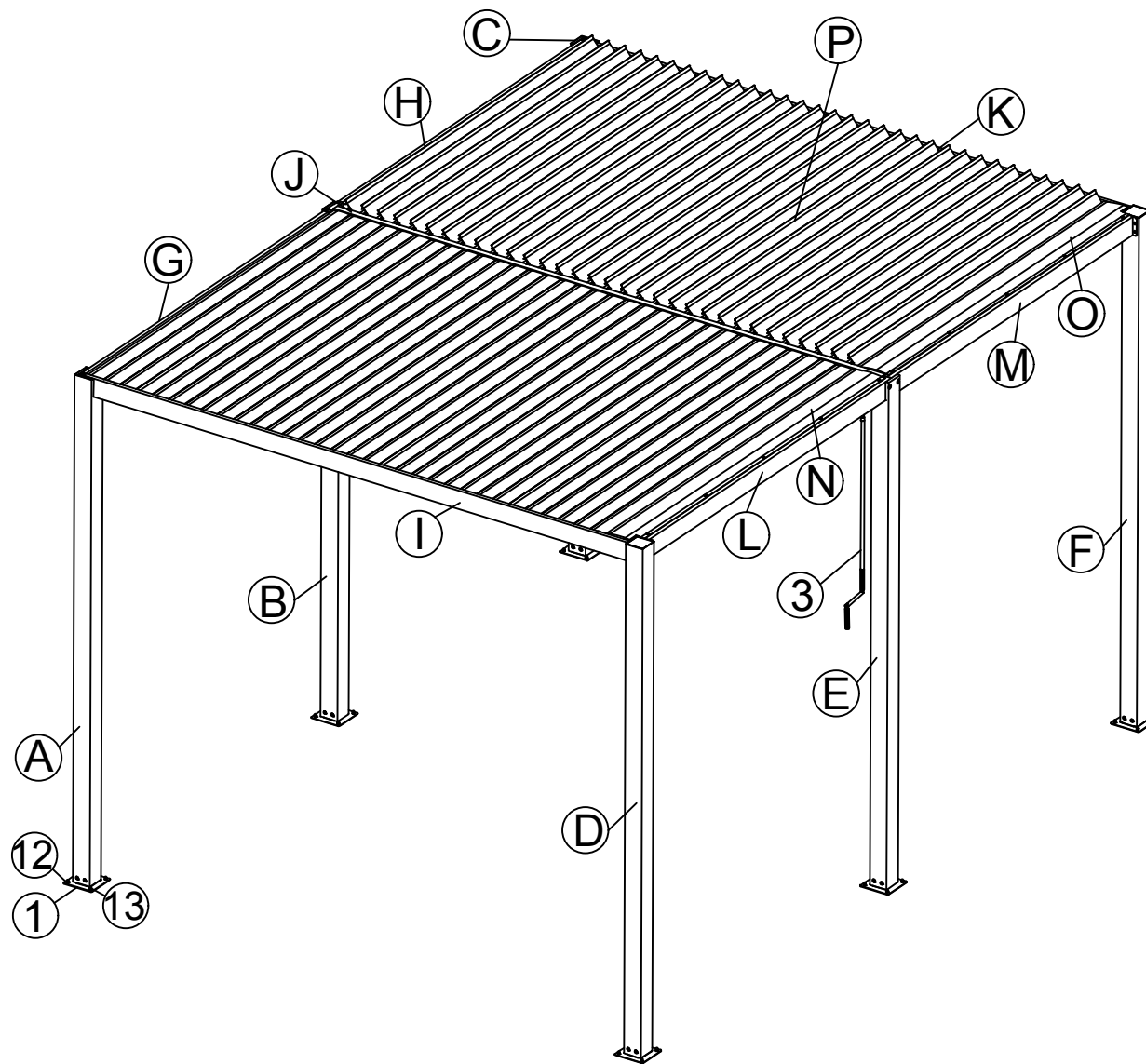

## Bruksmodus

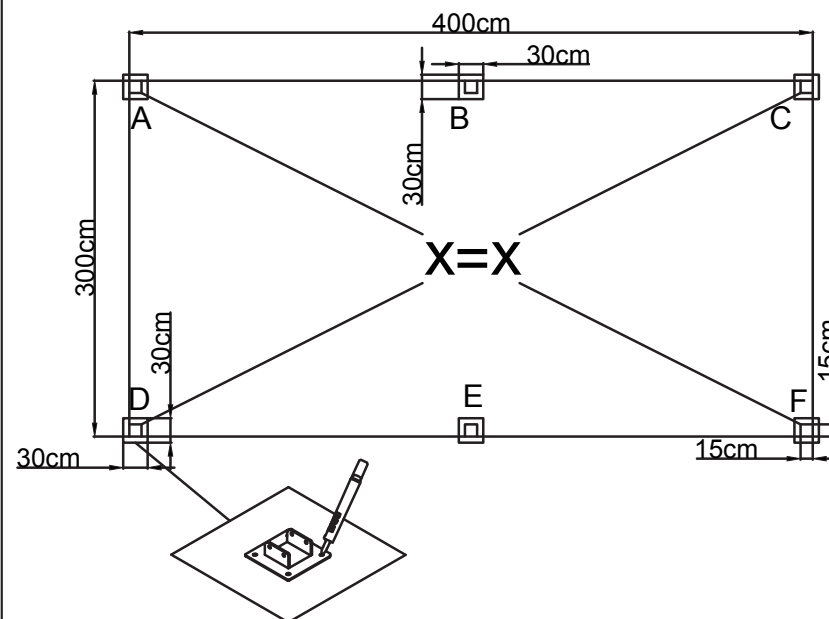
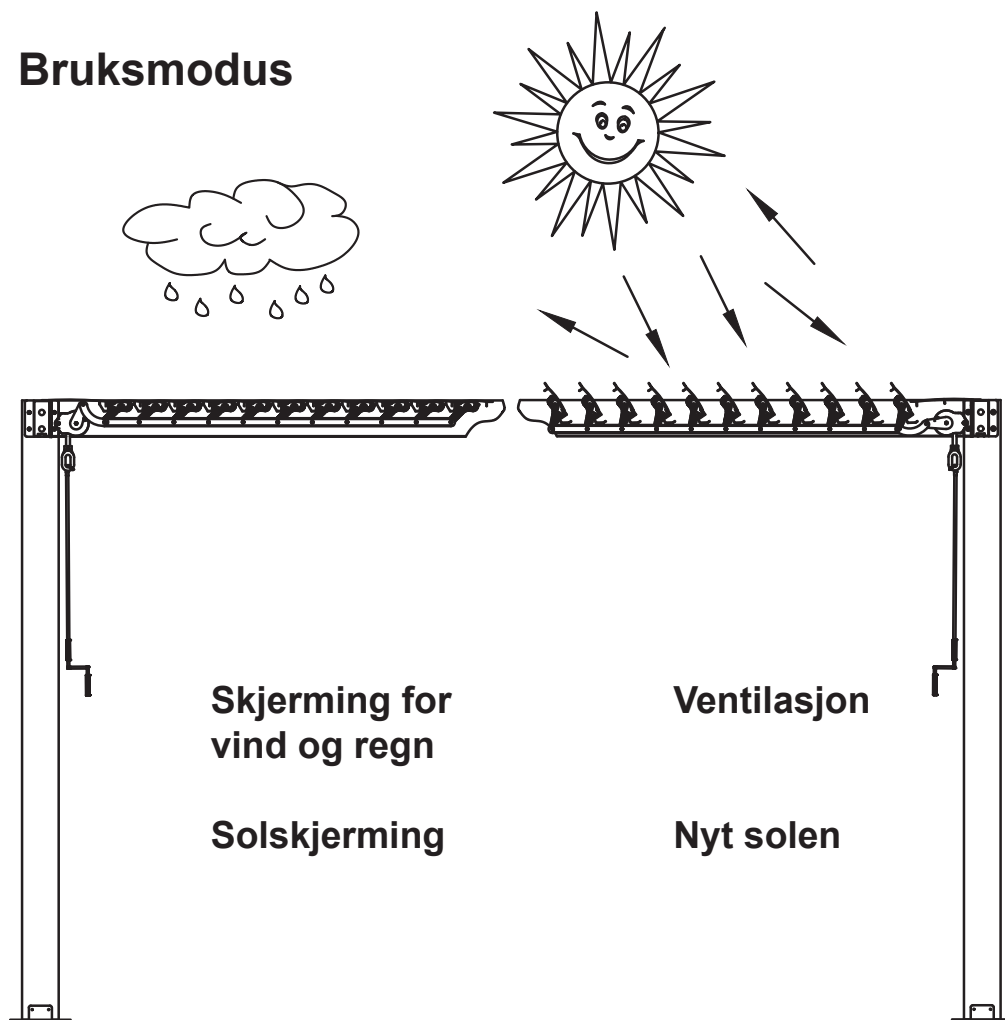

Sørg for å helle 30x30x30cm betong under hver stolpe for å få stabilitet til produktinstallasjonen.

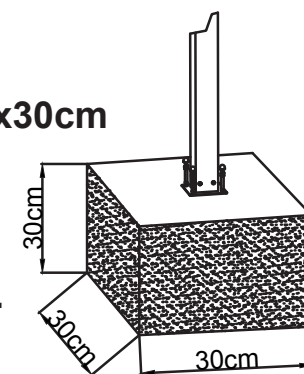

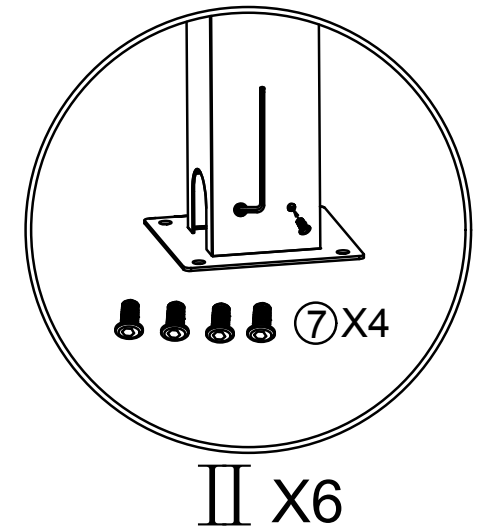
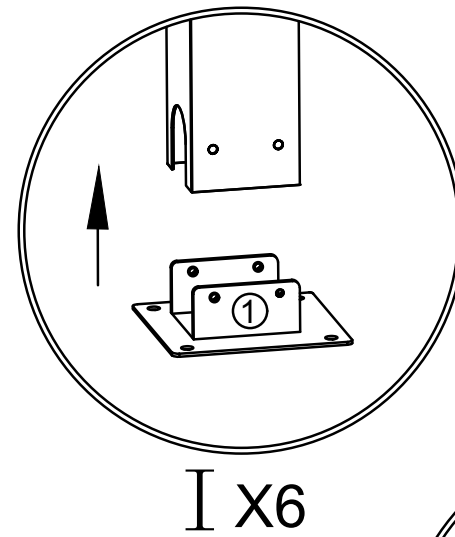
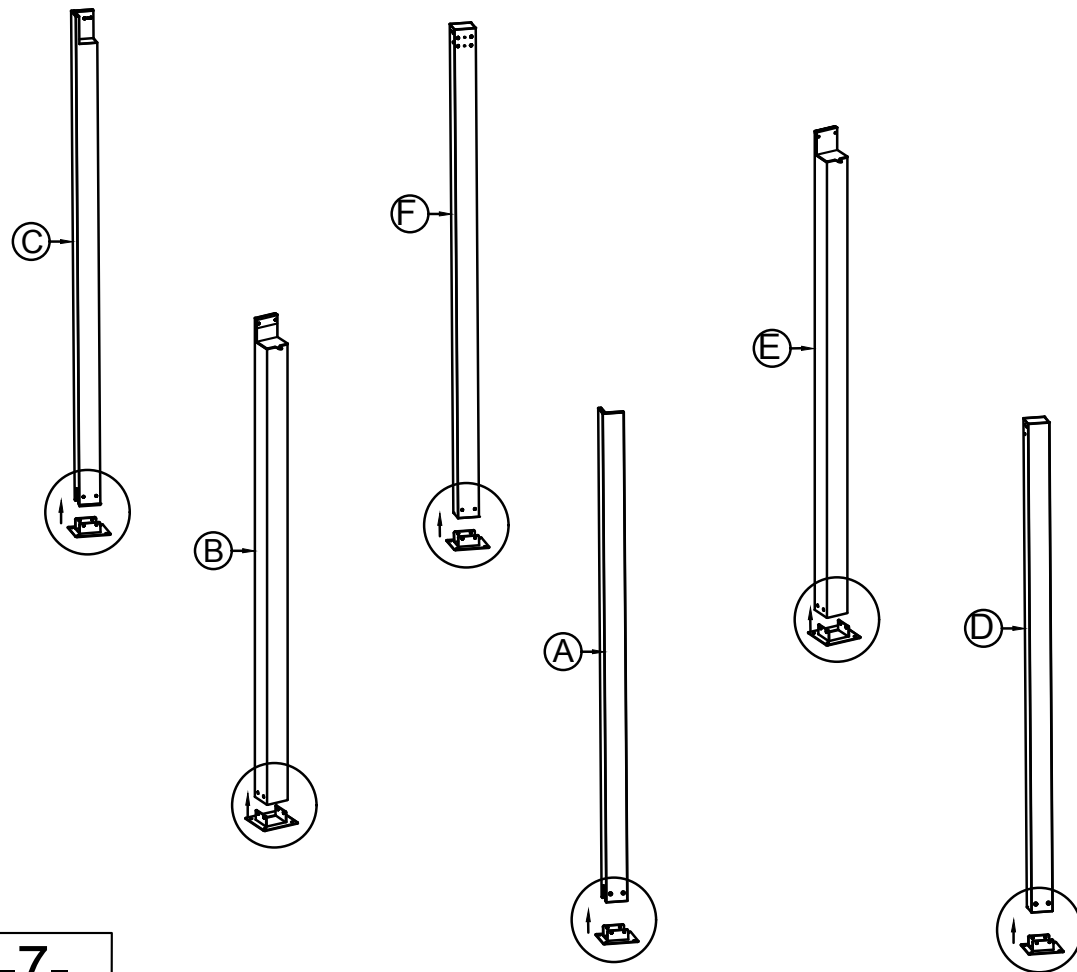
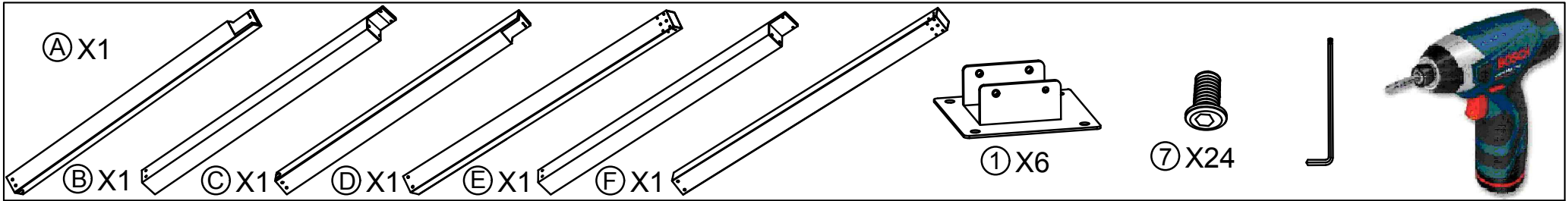

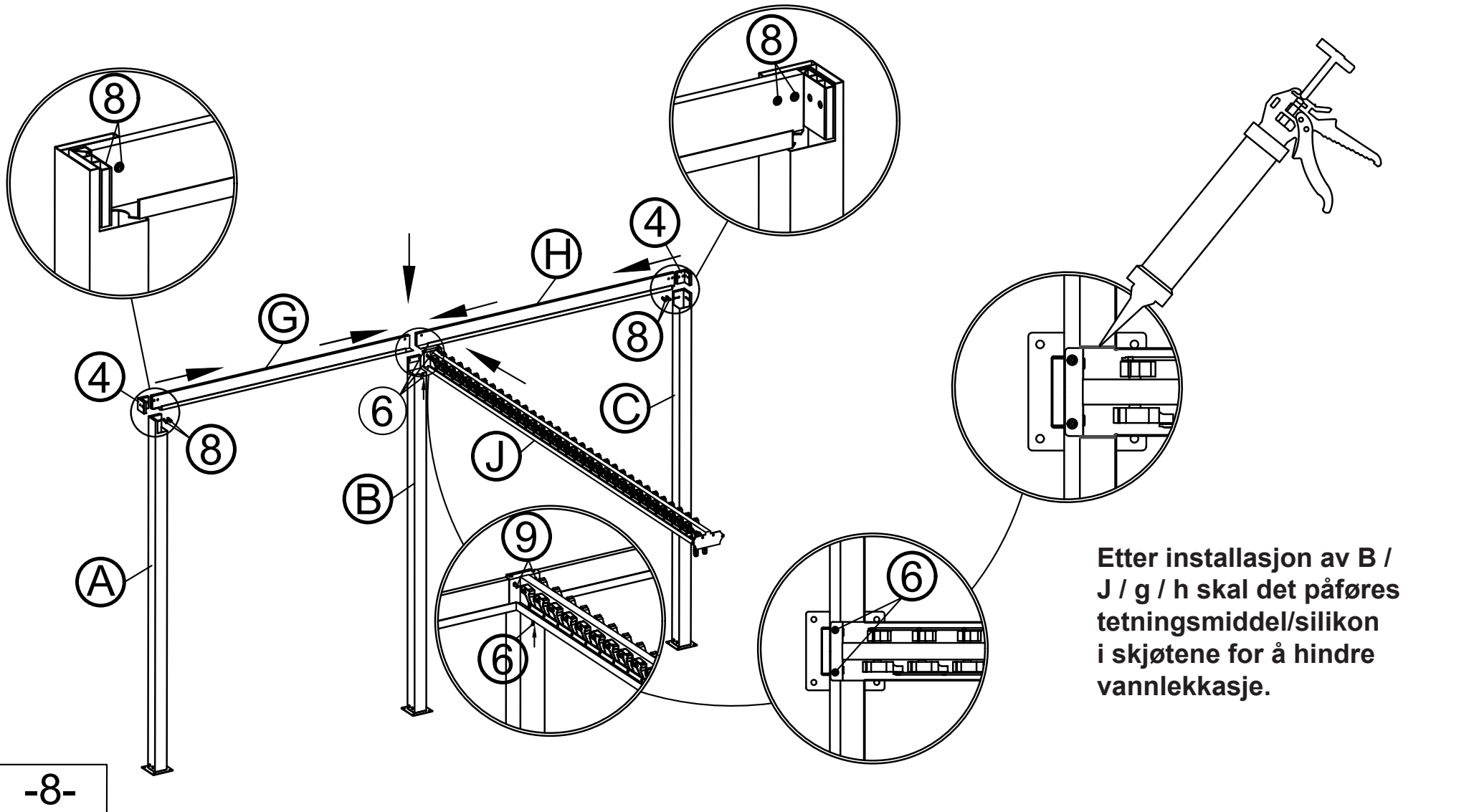
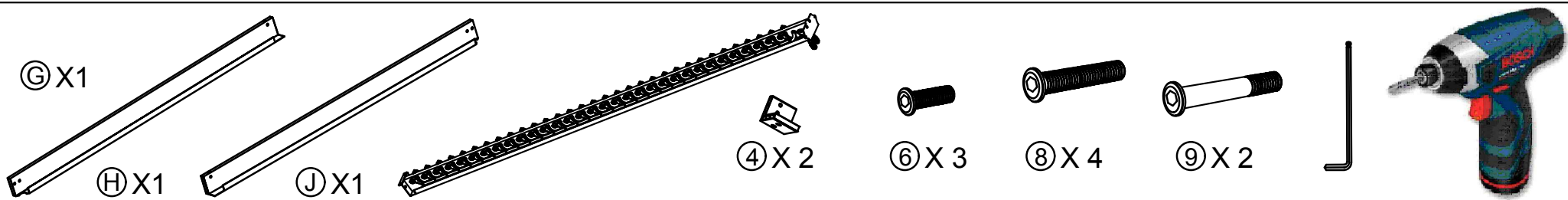



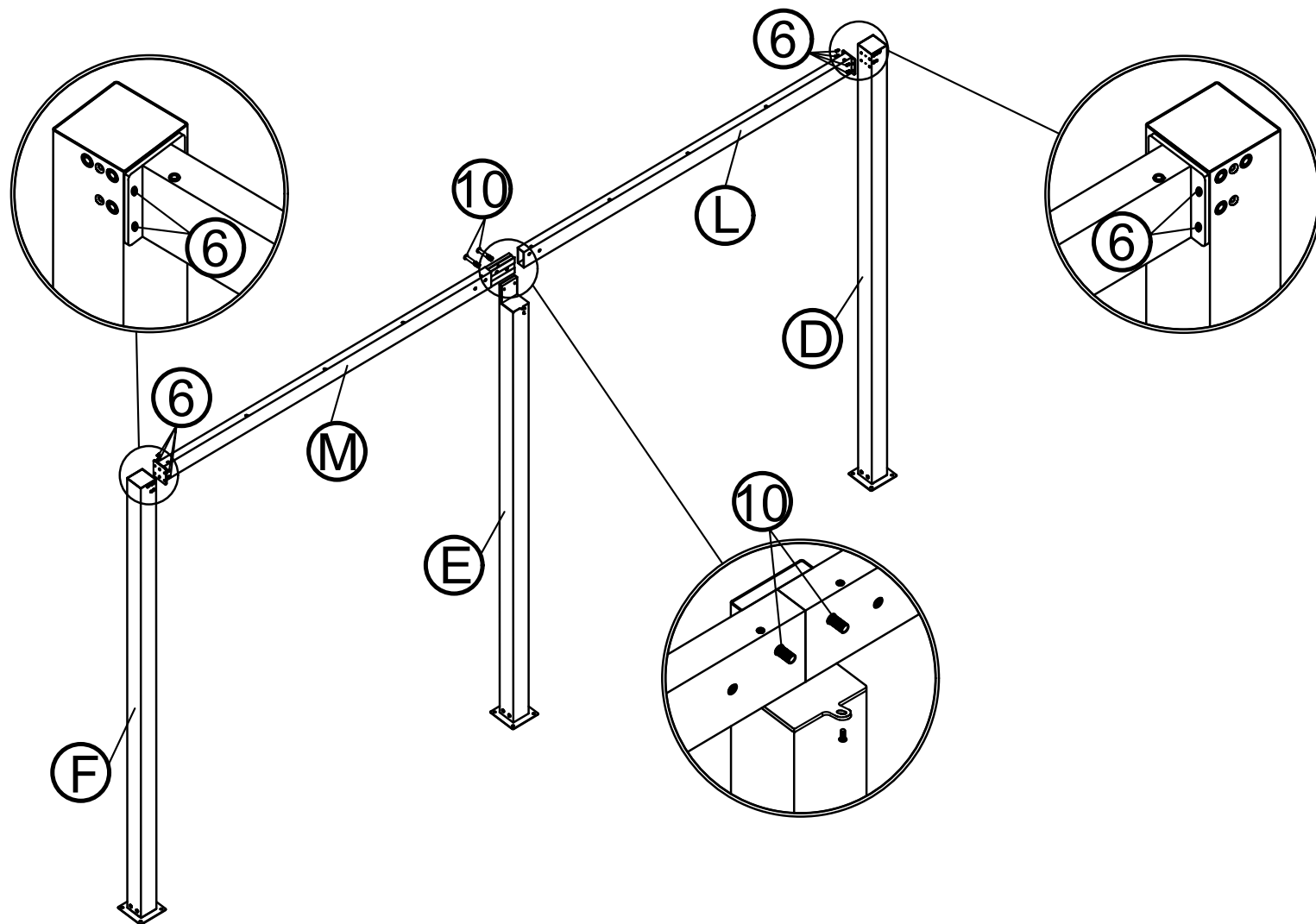
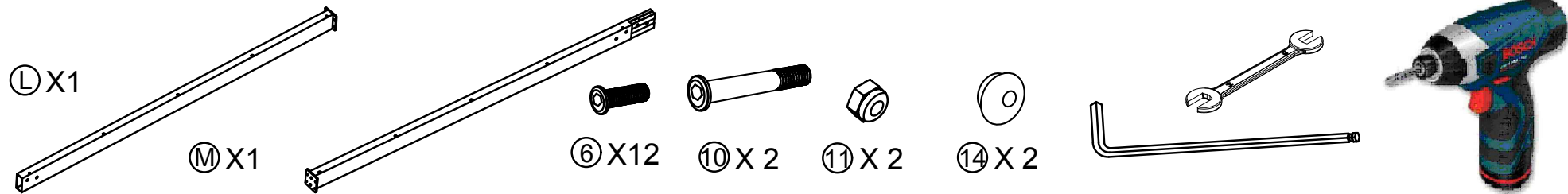

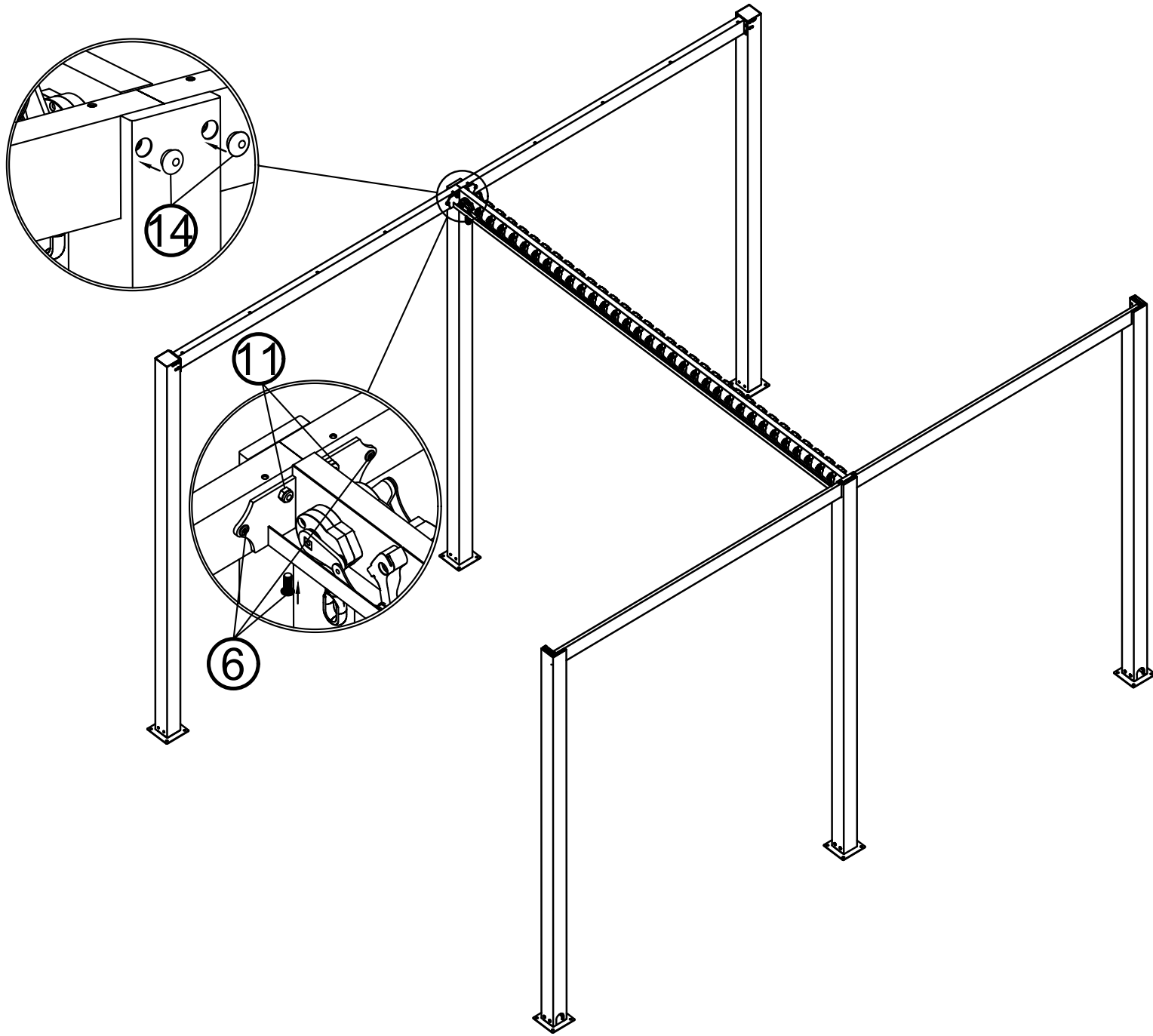

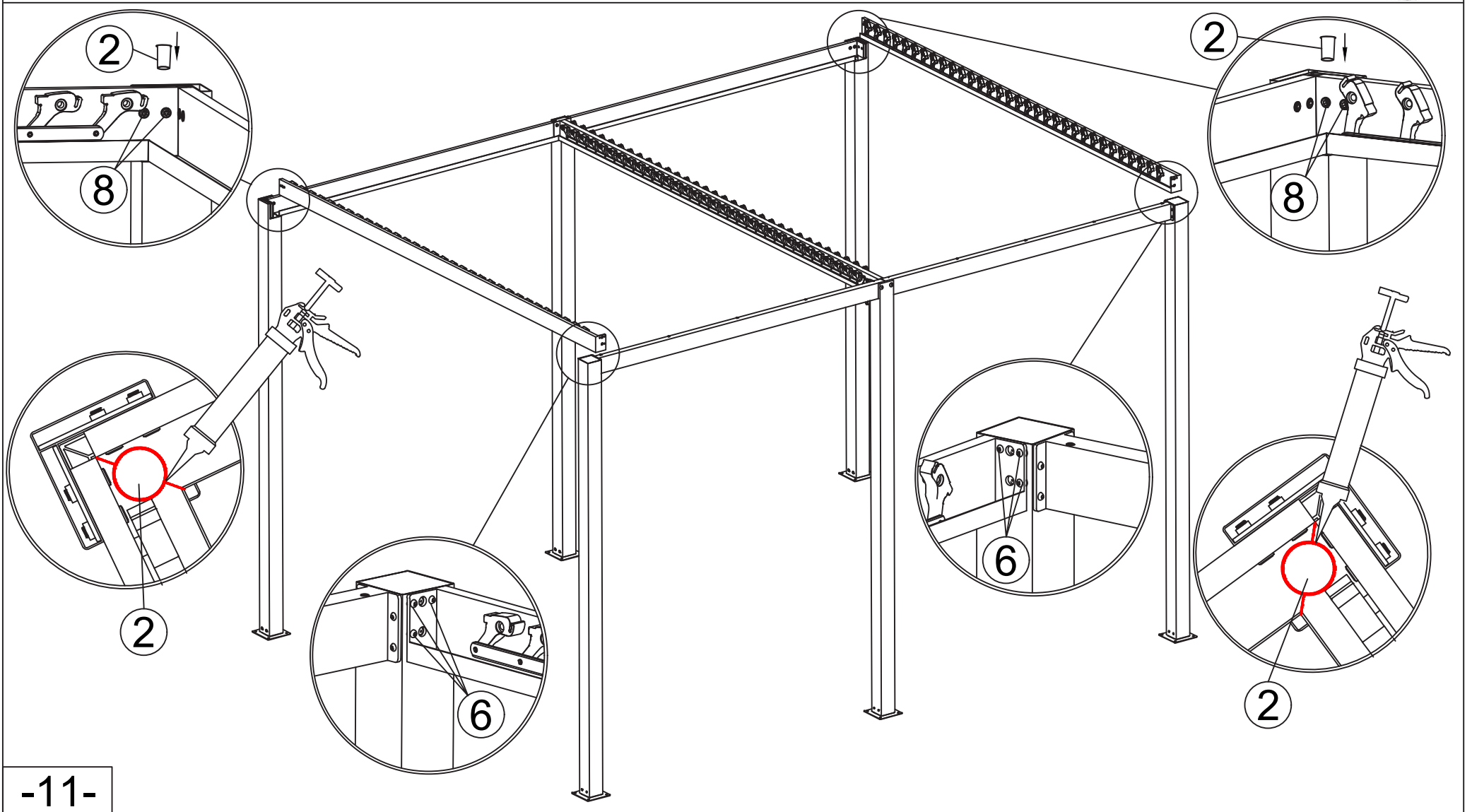
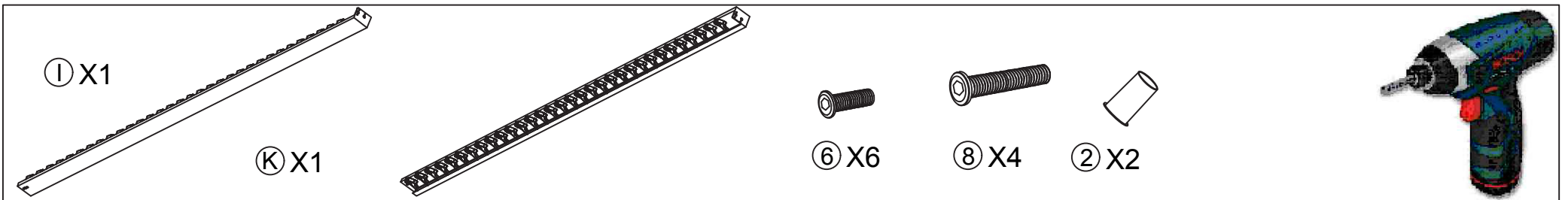

Ⓟ X64

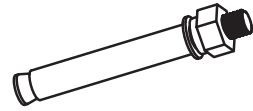
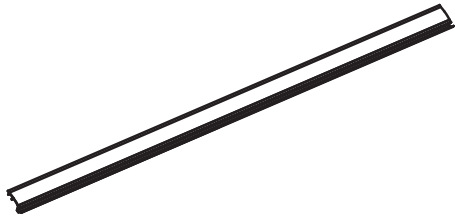

Ⓜ X24



Ⓝ X24

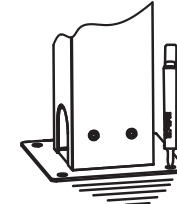
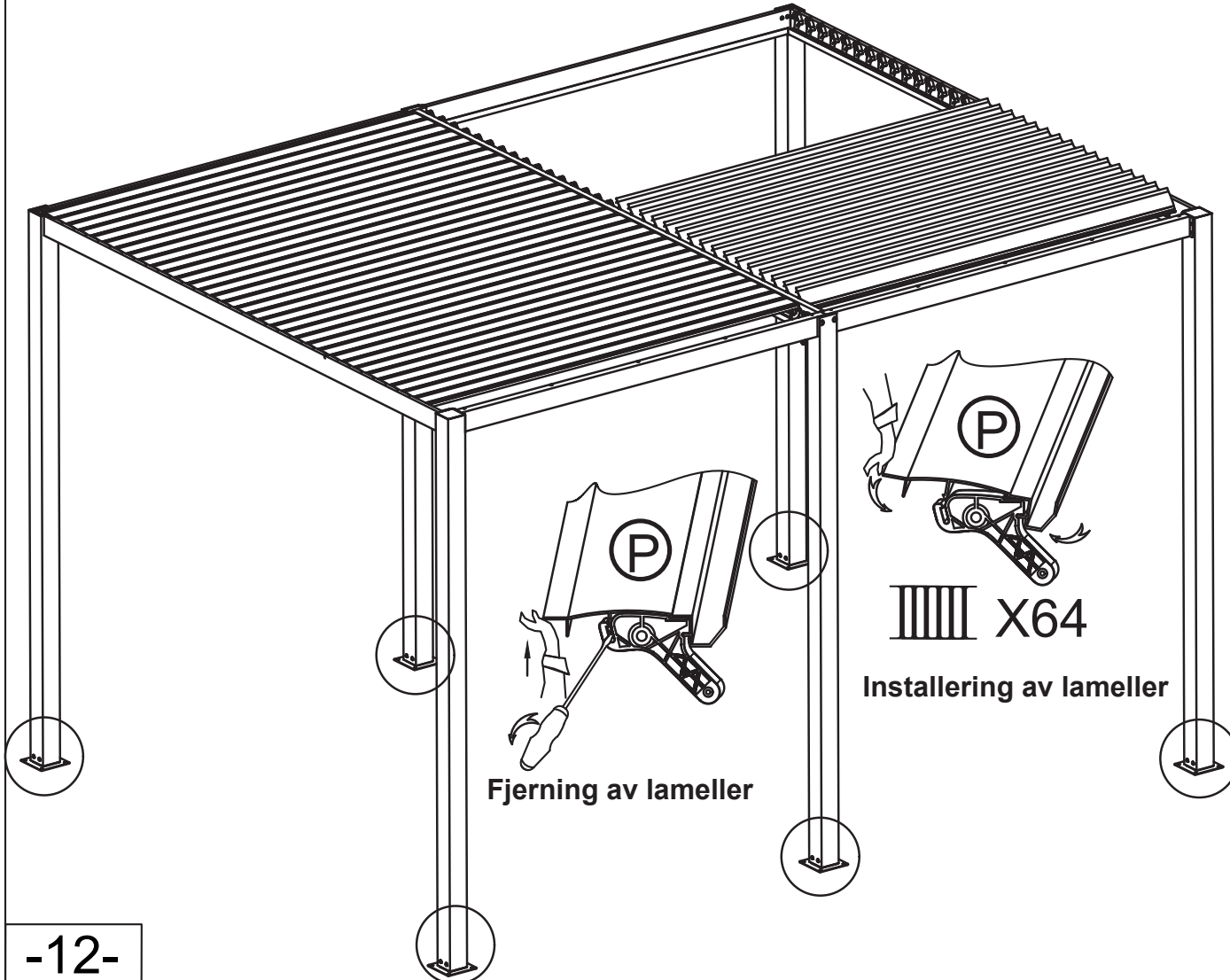
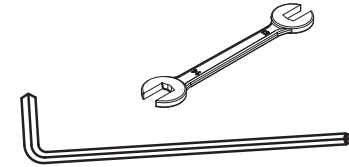

I X6

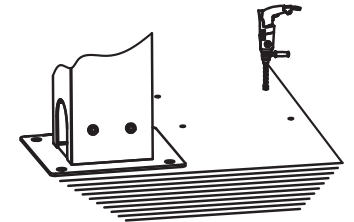

II X6

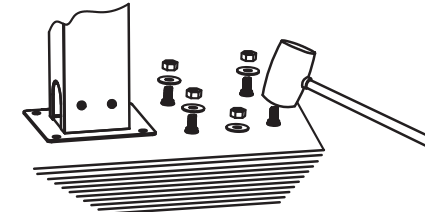

III X6

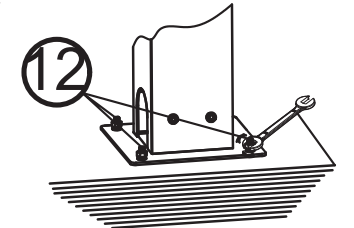

Ⓜ

III X6

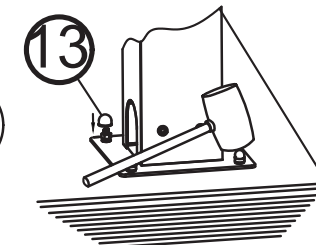

Ⓝ

III X6

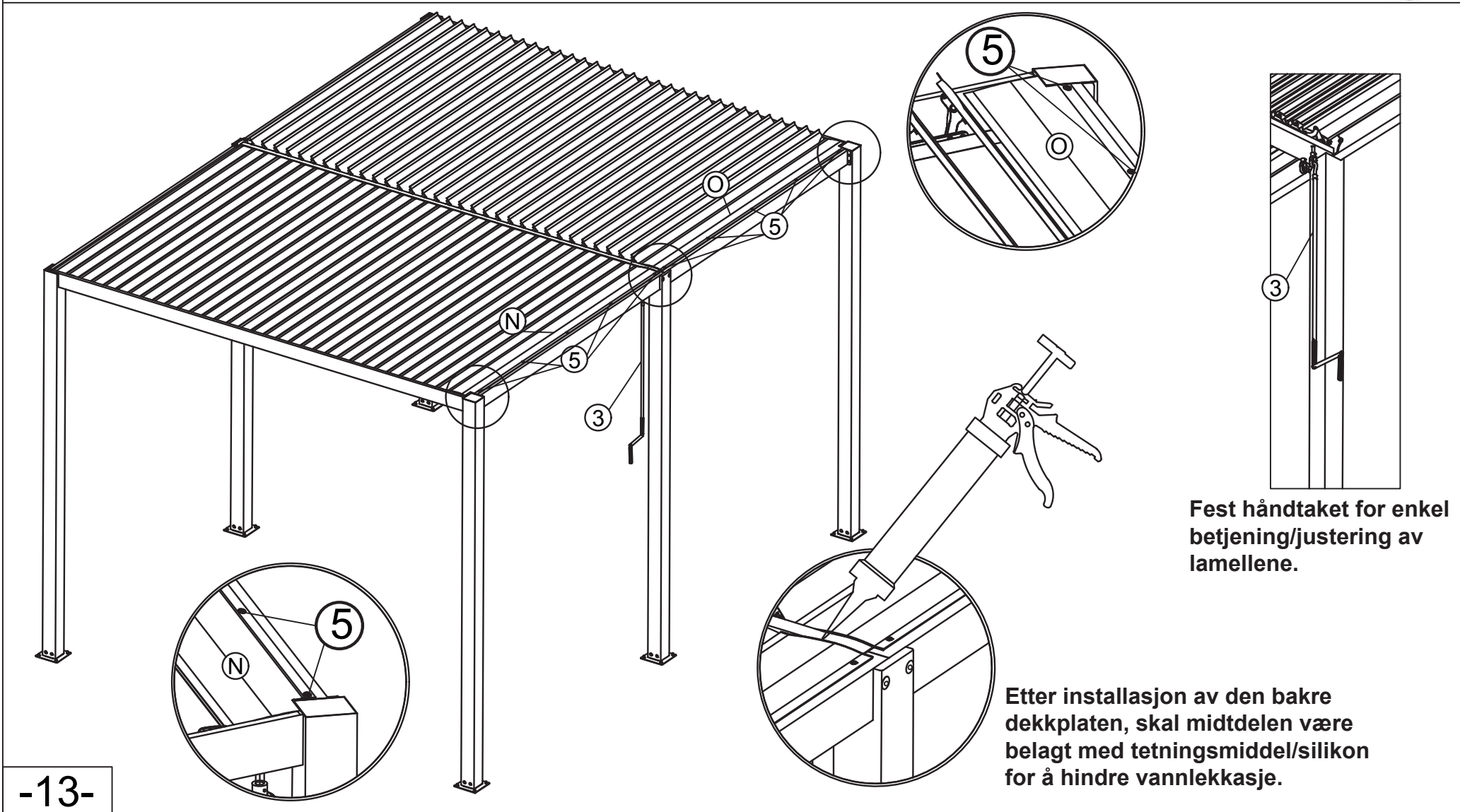

Fest håndtaket for enkel betjening/justering av lamellene.

Etter installasjon av den bakre dekkplaten, skal midtdelen være belagt med tetningsmiddel/silikon for å hindre vannlekkasje.